

# REVOLUTION

PISTON **PD** DRIVEN

OWNER'S MANUAL



TRUE. AMERICAN. ORIGINAL.

**Table of Contents**

Welcome to POF-USA ..... 2

**FIREARM SAFETY RULES**..... 3

STATE BY STATE WARNINGS ..... 4

FIREARM SAFETY RULES ..... 7

BREAK-IN PROCEDURES ..... 8

GENERAL OPERATION..... 9

OPERATION OF SAFETY..... 9

OPERATION OF BOLT CATCH.....10

MAGAZINES .....13

LOADING .....13

INSERTING .....14

REMOVING .....14

LOAD AND FIRE WITH MAGAZINE .....15

LOAD AND FIRE WITHOUT MAGAZINE ..... 16

UNLOAD.....16

TO RELOAD THE FIREARM.....17

EXTRACT AND EJECT A CHAMBERED CARTRIDGE ..... 17

REMOVE A BORE OBSTRUCTION..... 18

CLEAR A MALFUNCTION ..... 19

MINIMIZE MALFUNCTIONS..... 20

DISASSEMBLY ..... 20

Gas Plug Orientation .....22

BOLT CARRIER GROUP .....24

After removing the Bolt Carrier Group (BCG) and the charging handle from the upper receiver, you can set the upper receiver aside. ....24

Disassembly of the bolt carrier group (BCG):.....24

REASSEMBLY ..... 26

CARE AND CLEANING ..... 27

WARRANTY POLICIES..... 28

Maintenance and Wear Parts ..... 28

“Wearable” or “Consumable” Parts..... 29

ADDITIONAL TECHNICAL INFORMATION AND RECOMMENDATIONS ..... 30



## Welcome to POF-USA

Patriot Ordnance Factory, Inc. (POF-USA) is an American owned and operated small business with facilities headquartered in Phoenix, Arizona. All POF-USA firearms are American made. POF-USA firearms are engineered and tested to assure they meet the highest standards for durability and performance. Read this manual in its entirety before attempting to operate your POF-USA firearm. In addition, POF-USA recommends that you receive proper training in the handling of firearms prior to handling any firearm.



# WARNING



Please read the instructions and warnings contained in this manual BEFORE attempting to handle, load or utilize the POF-USA family of firearms. Even if you are familiar with the standard AR-10, AR-15, M-16, and/or M-4 family of firearms, you need to familiarize yourself with POF-USA firearms and their accessories before using them in any manner. Failure to do so could result in damage to the firearm, bodily injury to the shooter or bystanders, or even death.

POF-USA firearms are designed and built to use factory manufactured cartridges only. Using hand-loaded, remanufactured, reloaded, or other non-standard ammunition could result in serious malfunction, damage to the firearm, or serious bodily injury to the shooter or bystanders, or even death. POF-USA, Inc. is not liable for any damage to the firearm, bodily injury to person(s), or damage to any property resulting from the use or misuse of any firearm. This manual should accompany this firearm at all times. A replacement copy can be obtained anytime by visiting our website at [www.pof-usa.com](http://www.pof-usa.com).

The safety warnings are for the protection of the owner and operator of this POF-USA firearm as well as the safety of others. Disregarding information in this manual or failure to follow the basic rules of safe firearms handling can result in property damage, bodily injury and even death.

## FIREARM SAFETY RULES

1. **Treat all firearms as if they are loaded.** Always assume that a firearm is loaded even if you think it is unloaded. Every time a firearm is handled, for any reason, check to see that it is unloaded. If you are unable to check a firearm to see if it is unloaded, leave it alone and seek help from someone more knowledgeable about firearms.
2. **Keep the firearm pointed in the safest possible direction.** Always be aware of where a firearm is pointing. A "safe direction" is one where an accidental discharge of the firearm will not cause injury or damage. Only point a firearm at an object you intend to shoot. Never point a firearm toward yourself or another person.
3. **Keep your finger off the trigger until you are ready to shoot.** Always keep your finger off the trigger and outside the trigger guard until you are ready to shoot. Even though it may be comfortable to rest your finger on the trigger, it also is unsafe. If you are moving around with your finger on the trigger and stumble or fall, you could inadvertently pull the trigger. Sudden loud noises or movements can result in an accidental discharge because there is a natural tendency to tighten the muscles when startled. The trigger is for firing and the handle is for handling.
4. **Know your target, its surroundings and beyond.** Check that the areas in front of and behind your target are safe before shooting. Be aware that if the bullet misses or completely passes through the target, it could strike a person or object. Identify the target and make sure it is what you intend to shoot. If you are in doubt, DON'T SHOOT! Never fire at a target that is only a movement, color, sound or unidentifiable shape. Be aware of all the people around you before you shoot.
5. **Know how to properly operate your firearm.** It is important to become thoroughly familiar with your firearm. You should know its mechanical characteristics including how to properly load, unload and clear a malfunction from your firearm. Obviously, not all firearms are mechanically the same. Never assume that what applies to one make or model is exactly applicable to another. You should direct questions regarding the operation of your firearm to your firearms dealer, or contact the manufacturer directly.
6. **Store your firearm safely and securely to prevent unauthorized use.** Firearms and ammunition should be stored separately. When the firearm is not in your hands, you must still think of safety. Use a safety device on the firearm, such as a trigger lock or cable lock, so it cannot be fired. Store it unloaded in a locked container, such as a lock box or a firearm safe. Store your firearm in a different location than the ammunition. For maximum safety, you should use both a locking device and a storage container.
7. **Never use Alcohol, Over The Counter, Prescription, or other drugs before or while shooting.** These substances are likely to impair normal mental or physical bodily functions and must not be used before or while handling or shooting firearms.

PROTECT OUR CHILDREN



**STORE YOUR FIREARMS RESPONSIBLY**

**STATE BY STATE WARNINGS**

Some states require by law that specified warning notices in “larger-than-normal” type be conspicuously included by the manufacturer, distributor, or retailer with firearms sold in that state. Since our products may be sold in those states, we include the following:

**California:**

 **WARNING**

 **ADVERTENCIA**

“Children are attracted to and can operate firearms that can cause severe injuries or death. Prevent child access by always keeping guns locked away and unloaded when not in use. If you keep a loaded firearm where a child obtains and improperly uses it, you may be fined or sent to prison.”

“Los niños se sienten atraídos y se puede operar las armas de fuego que pueden causar lesiones graves o la muerte. Evitar el acceso niño siempre manteniendo las armas bajo llave y descargadas cuando no esté en uso. Si usted mantiene un arma de fuego cargada en que un niño obtiene y utiliza inadecuadamente, usted puede recibir una multa de enviado a la cárcel”.

**Connecticut:**

“UNLAWFUL STORAGE OF A LOADED FIREARM MAY RESULT IN IMPRISONMENT OR FINE”

**Florida:**

“IT IS UNLAWFUL, AND PUNISHABLE BY IMPRISONMENT AND FINE, FOR ANY ADULT TO STORE OR LEAVE A FIREARM IN ANY PLACE WITHIN THE REACH OR EASY ACCESS OF A MINOR UNDER 18 YEARS OF AGE OR TO KNOWINGLY SELL OR OTHERWISE TRANSFER OWNERSHIP OR POSSESSION OF A FIREARM TO A MINOR OR A PERSON OF UNSOUND MIND”



**Maine:**

“ENDANGERING THE WELFARE OF A CHILD IS A CRIME. IF YOU LEAVE A FIREARM AND AMMUNITION WITHIN EASY ACCESS OF A CHILD, YOU MAY BE SUBJECT TO FINE, IMPRISONMENT OR BOTH. KEEP FIREARMS AND AMMUNITION SEPARATE. KEEP FIREARMS AND AMMUNITION LOCKED UP. USE TRIGGER LOCKS.”

**Maryland:**

“WARNING: Children can operate firearms which may cause death or serious injury. It is a crime to store or leave a loaded firearm in any location where an individual knew or should have known that an unsupervised minor would gain access to the firearm. Store your firearm responsibly!”

**Massachusetts:**

“WARNING FROM THE MASSACHUSETTS ATTORNEY GENERAL: This handgun is not equipped with a device that fully blocks use by unauthorized users. More than 200,000 firearms like this are stolen from their owners every year in the United States. In addition, there are more than a thousand suicides each year by younger children and teenagers who get access to firearms. Hundreds more die from accidental discharge. It is likely that many more children sustain serious wounds, or inflict such wounds accidentally on others. In order to limit the chance of such misuse, it is imperative that you keep this weapon locked in a secure place and take steps necessary to limit the possibility of theft or accident. Failure to take reasonable preventive steps may result in innocent lives being lost, and in some circumstances may result in your liability for these deaths.”

“IT IS UNLAWFUL TO STORE OR KEEP A FIREARM, RIFLE, SHOTGUN, OR MACHINE GUN, IN ANY PLACE UNLESS THAT WEAPON IS EQUIPPED WITH A TAMPER-RESISTANT SAFETY DEVICE OR IS STORED OR KEPT IN A SECURLY LOCKED CONTAINER.”

**New Jersey:**

“IT IS A CRIMINAL OFFENSE TO LEAVE A LOADED FIREARM WITHIN EASY ACCESS OF A MINOR.”



**North Carolina:**

“IT IS UNLAWFUL TO STORE OR LEAVE A FIREARM THAT CAN BE DISCHARGED IN A MANNER THAT A REASONABLE PERSON SHOULD KNOW IS ACCESSIBLE TO A MINOR.”

**Texas:**

“IT IS UNLAWFUL TO STORE, TRANSPORT, OR ABANDON AN UNSECURED FIREARM IN A PLACE WHERE CHILDREN ARE LIKELY TO BE AND CAN OBTAIN ACCESS TO THE FIREARM.”

**Wisconsin:**

“IF YOU LEAVE A LOADED FIREARM WITHIN THE REACH OR EASY ACCESS OF A CHILD YOU MAY BE FINED OR IMPRISONED OR BOTH IF THE CHILD IMPROPERLY DISCHARGES, POSSESSES, OR EXIBITS THE FIREARM.”

\*\*\*\*\*

**As a responsible firearm owner it is your responsibility to be aware of any local, state, or federal laws governing the lawful ownership of firearms. The above is not all inclusive of all states and is subject to change. Please check with your local retailer, state police, and local law enforcement for current regulations in your area.**

**Visit the NRA website ([www.nra.org](http://www.nra.org)) or the BATFE website ([www.atf.gov](http://www.atf.gov)) for further information.**

\*\*\*\*\*



## FIREARM SAFETY RULES

- 1. Treat all firearms as if they are loaded.** Always assume that a firearm is loaded even if you think it is unloaded. Every time a firearm is handled, for any reason, check to see that it is unloaded. If you are unable to check a firearm to see if it is unloaded, leave it alone and seek help from someone more knowledgeable about firearms.
- 2. Keep the firearm pointed in the safest possible direction.** Always be aware of where a firearm is pointing. A "safe direction" is one where an accidental discharge of the firearm will not cause injury or damage. Only point a firearm at an object you intend to shoot. Never point a firearm toward yourself or another person.
- 3. Keep your finger off the trigger until you are ready to shoot.** Always keep your finger off the trigger and outside the trigger guard until you are ready to shoot. Even though it may be comfortable to rest your finger on the trigger, it also is unsafe. If you are moving around with your finger on the trigger and stumble or fall, you could inadvertently pull the trigger. Sudden loud noises or movements can result in an accidental discharge because there is a natural tendency to tighten the muscles when startled. The trigger is for firing and the handle is for handling.
- 4. Know your target, its surroundings and beyond.** Check that the areas in front of and behind your target are safe before shooting. Be aware that if the bullet misses or completely passes through the target, it could strike a person or object. Identify the target and make sure it is what you intend to shoot. If you are in doubt, DON'T SHOOT! Never fire at a target that is only a movement, color, sound, or unidentifiable shape. Be aware of all the people around you before you shoot.
- 5. Know how to properly operate your firearm.** It is important to become thoroughly familiar with your firearm. You should know its mechanical characteristics including how to properly load, unload and clear a malfunction from your firearm. Obviously, not all firearms are mechanically the same. Never assume that what applies to one make or model is exactly applicable to another. You should direct questions regarding the operation of your firearm to your firearms dealer or contact the manufacturer directly.
- 6. Store your firearm safely and securely to prevent unauthorized use.** Firearms and ammunition should be stored separately. When the firearm is not in your hands, you must still think of safety. Use a safety device on the firearm, such as a trigger lock or cable lock, so it cannot be fired. Store it unloaded in a locked container, such as a lock box or a firearm safe. Store your firearm in a different location than the ammunition. For maximum safety, you should use both a locking device and a storage container.
- 7. Never use Alcohol, Over the Counter, Prescription, or other drugs before or while shooting.** These substances are likely to impair normal mental or physical bodily functions and must not be used before or while handling or shooting firearms.





## BREAK-IN PROCEDURES

Please read "Breaking In Your New Firearm" and watch the video under "Cleaning Procedures" both of which can be found on our technical page. Make sure you clean and lube your weapon using the techniques shown in the video, especially the cleaning of the chamber (chamber brush attached to a drill).

### Breaking In Your New Firearm

1. Thoroughly clean the chamber of your new firearm, and clean after every shooting session. Check out our links on the technical page for cleaning procedures and tips <http://pof-usa.com/support/> & <https://youtu.be/AGQ-4avqHqA>
2. Generously lube the bolt carrier group (BCG) with your favorite firearm lubricant. As your firearm breaks in less lubrication will be needed and after a few hundred rounds just a light wipe will be sufficient.
3. Put a little lubricant in the buffer tube.
4. There is no break-in required for the barrel, just clean it at the end of each shooting session.
5. POF-USA only recommends the use of factory new ammo and cannot offer you advice or tips regarding hand loading or re-loaded ammo.

## GENERAL OPERATION

### OPERATION OF SAFETY

The manual safety mechanism is located above the trigger on the left side (and right if ambidextrous equipped) of the lower receiver. The safety can be moved to “SAFE”  (bullet with an X pictograph) anytime the hammer is cocked. When the safety is on, it blocks the trigger. The safety should always be kept in “SAFE” mode when loading or unloading the firearm and should be kept in “SAFE” mode at all times unless firing the firearm. Firearms are in the “SAFE” position when the lever is in a horizontal position. (See Figures 1 & 2 below).



**Figure 1**  
“SAFE”



**Figure 2**  
“FIRE”

Keep the safety on unless firing. Always move the safety fully to its intended position and check it. The safety is not “ON” unless it is completely “ON”. Never depend on a safety mechanism or any mechanical device to justify careless handling or permitting the firearm to point in an unsafe direction. The only “safe” firearm is one in which the bolt is open, the chamber is empty, and there is no magazine in it.

### **KNOW HOW TO USE THE SAFETY**

## OPERATION OF BOLT CATCH

POF-USA firearms are designed so that the bolt will remain open after the last shot has been fired, provided there is a correctly functioning magazine in the firearm. When the magazine is empty, the magazine follower engages the bolt catch, which retains the bolt carrier group (BCG), in the rearward position.

\*\*\*\*\*

**\*WARNING: The bolt catch is NOT a safety device. It should not be used to hold back the bolt when there are cartridges in the magazine. A slight jar to the butt end of the firearm can cause the bolt catch to disengage allowing the BCG to go forward and feed a cartridge into the chamber.**

\*\*\*\*\*

\*The bolt catch should be used to hold the bolt in its rearward position only when the chamber is empty, and an empty magazine is in place. The bolt catch is there for convenience when changing magazines.

To hold the bolt carrier group (BCG) open:

1. Put safety on "SAFE". 
2. Pull the charging handle all the way to the rear.
3. Depress the bottom part of the bolt catch and allow the bolt carrier to move forward until it stops. **(See Figure 3)** Or press up on the bolt latch located in the center of the trigger guard while pulling back on the charging handle, then allowing the BCG to move forward onto the catch. **(See Figure 4)**



Figure 3



**Figure 4**

To release the bolt carrier, allowing the bolt to move forward, KEEP SELECTOR ON SAFE and either:

1. Remove the magazine; draw the charging handle to the rear and release. Allow the handle to spring forward freely. Do not “ride” the charging handle or otherwise retard the forward motion.
2. Push the top part of the bolt catch toward the lower receiver and the bolt carrier will release. **(See Figure 5)**
3. Push in on the ambi lever on the right side of the lower receiver and the bolt carrier will release. **(See Figure 6)**



**Figure 5**



**Figure 6**

**CAUTION: Bolt carrier group (BCG) is under heavy spring tension and can injure fingers when it slams shut.**

AMMUNITION

POF-USA only recommends the use of factory new ammunition loaded in accordance with U.S. industry practice and cannot offer any advice or tips regarding hand loaded or reloaded ammunition. Damages due to high pressure, reloaded, or non-standard ammunition is not covered under warranty.

Death, serious injury and damage can result from the use of wrong ammunition; bore obstructions, powder overloads, or incorrect cartridge components. Always wear eye protection and hearing protection while discharging your firearm.

**ONLY USE  
FACTORY  
AMMUNITION  
LOADED TO U.S.  
INDUSTRY  
STANDARDS**

POF-USA SPECIFICALLY DISCLAIMS ANY RESPONSIBILITY FOR ANY DAMAGE OR INJURY WHATSOEVER OCCURRING IN CONNECTION WITH, OR AS A RESULT OF, THE USE IN POF-USA FIREARMS OF FAULTY, OR NON-STANDARD, OR "REMANUFACTURED", OR HAND LOADED (RELOADED) AMMUNITION, OR OF CARTRIDGES OTHER THAN THOSE FOR WHICH THE FIREARM WAS ORIGINALLY CHAMBERED



## *WARNING-LEAD EXPOSURE*

Discharging firearms in poorly ventilated areas, cleaning firearms, or handling ammunition may result in exposure to lead and other substances known to the State of California to cause birth defects, reproductive harm, and other serious physical injury. Wash hands thoroughly after exposure.

**SHOOTING OR CLEANING GUNS MAY EXPOSE YOU TO LEAD**

### **MAGAZINES**

- ❖ 7.62x51/.308 and 6.5 Creedmoor caliber firearms are normally supplied with one 20 round magazines.

Firearms supplied to states with magazine restrictions are shipped with the appropriate magazine based upon the state restriction.

*DAMAGED, NON-STANDARD, OR IMPROPERLY ASSEMBLED MAGAZINES*

*SHOULD NOT BE USED – THEY CAN CAUSE THE FIREARM TO MALFUNCTION*

### **LOADING**

Use only clean, dry ammunition of the proper caliber manufactured to U.S. Industry specifications, in good condition. With the short end of the magazine facing forward, place a round between the feed lips of the magazine with the bullet forward. Press the round down until it is held by the magazine feed lips. Place the next round and repeat until the desired number of cartridges are loaded.



## INSERTING

The magazine may be inserted with the bolt carrier either closed or open (see OPERATION OF BOLT CATCH Page 10 & 11). More force will be required to insert the magazine with the bolt in the closed position in order to overcome the bolt carrier group.

1. Hold the magazine as shown and insert it into the magazine well until it is seated/latched. **(See figure 7)**
2. Check to assure it is securely latched in place by pulling on the magazine, it should not come out.



**Figure 7**

## REMOVING

To remove the magazine, push the magazine catch button towards the lower receiver from the right side **(See Figure 8)** until the magazine drops out of the magazine well. Or press in on the Ambi lever on the left side of the lower receiver until the magazine drops out of the magazine well. Avoid letting the magazine drop to the ground, this will prevent the possibility of damage to the magazine and minimize the possibility of magazine related malfunctions. If the magazine is completely full of ammunition, you may need to assist it's removal by applying a slight downward tug on the magazine body until it clears the magazine well.



**Figure 8**

## LOAD AND FIRE WITH MAGAZINE

**Safe firearm handling should be practiced with an unloaded firearm until you can perform each of the following steps with skill and confidence. Please read this manual completely prior to operating your POF-USA firearm.**

1. Be certain the muzzle is pointed in a safe direction.
2. Before inserting a loaded magazine, engage the bolt catch so that the bolt carrier is held open. Verify the chamber is empty. Move the safety selector to the “ON” or “SAFE”  position.
3. Insert a loaded magazine into the magazine well and release the bolt catch by either depressing the pad on the left side or the lever on the right side. A cartridge will be stripped from the magazine and chambered by the motion of the bolt carrier moving forward.

---

*WARNING: If cartridges do not feed smoothly from the magazine into the chamber, then do not use the firearm until the problem is corrected (See CLEAR A MALFUNCTION, Page 17)*

---





4. The firearm is now cocked, and a cartridge is chambered. Visually check to be certain the safety is in the “ON” or the “SAFE”  position, and the firearm is pointed in a safe direction.

---

*WARNING: DO NOT TOUCH THE TRIGGER UNTIL YOU ARE ACTUALLY READY TO FIRE.*

*KEEP THE SAFETY “ON”  UNLESS ACTUALLY FIRING*

---

5. When you are ready to fire, move the safety to the “FIRE”  position.
6. The firearm will fire one shot each time the trigger is pulled until the magazine is empty. Some of the gas produced by the combustion of the powder in the cartridge is used to cycle the bolt carrier. This process ejects the fired cartridge case, re-cocks the firearm and loads a new cartridge from the magazine into the chamber.
7. Immediately following the firing of the cartridge and if no other cartridges are to be fired, put the safety in the “SAFE”  position while the firearm is still pointed in a safe direction. The safety should always be moved to the “SAFE”  position as soon as firing is completed, and it should be on “SAFE”  at all times except when the firearm is on target and being fired.



8. When the last cartridge in the magazine has been fired, the bolt catch should automatically engage and hold the bolt carrier in the rearward open position.

---

*IF DROPPED OR STRUCK WITH THE SAFETY "OFF", THE FIREARM MAY FIRE.*

*KEEP THE CHAMBER EMPTY UNLESS ACTUALLY FIRING!*

*KEEP THE SAFETY ON THE "SAFE"  POSITION UNLESS ACTUALLY FIRING!*

*ANY GUN MAY FIRE IF DROPPED*

---

## LOAD AND FIRE WITHOUT MAGAZINE

Your firearm can be used as a single shot in the absence of a magazine or for training purposes. To do so, follow steps 1 & 2 above then manually load a cartridge into the chamber. Then follow steps 4 & 5 (disregard magazine). Note that the bolt will not automatically lock back after the cartridge is fired and ejected. Engage the safety between shots.

### CAUTION:

**It is not recommended or advised to chamber the same round of ammunition multiple times. By doing this you could induce a slam fire scenario or a catastrophic cartridge failure.**

### UNLOAD





**WARNING:** This sequence must be followed exactly as spelled out. Failure to do so can result in the rifle's chamber becoming unintentionally loaded with a cartridge!

1. Keep the muzzle pointed in a safe direction at all times and keep fingers outside the trigger guard. Rotate the safety to the "SAFE"  position.
2. Remove the magazine. **REMEMBER** that even though the magazine has been removed, a cartridge remaining in the chamber can still be fired!
3. Pull the charging handle all the way to the rear, extracting and ejecting the cartridge in the chamber.

4. When the bolt carrier is fully retracted, lock the bolt carrier back using the appropriate method laid out on pages 10 & 11.
5. Always visually double check the chamber to be certain it is empty.
6. The only "safe" firearm is one in which the bolt carrier is open, and the chamber and magazine are empty, and the muzzle is pointed in a safe direction.



### TO RELOAD THE FIREARM

1. Firing all cartridges in the magazine and the chamber will cause the bolt carrier to automatically lock open. Keep the rifle pointed in a safe direction. Put the safety in the "SAFE"  position. Removal of the magazine can be accomplished by pressing inward on the magazine catch button with the thumb or forefinger. The magazine should fall free of the rifle of its own weight. To avoid the possibility of damage to the magazine, do not let it fall to the ground.
2. Insert a loaded magazine. **WARNING:** The bolt catch is held in place by friction between the bolt face and the rear surface of the bolt catch. Therefore, when there is a loaded magazine in place and the rifle is jarred, the bolt can release and chamber a cartridge.
3. Release the bolt carrier by the methods described on page 11. A cartridge will be chambered when the bolt carrier shuts. **WARNING:** The rifle is ready for instant use once the bolt carrier moves forward. If the rifle is not to be fired immediately, keep the safety on "SAFE" . When you are ready to fire, move the selector to the "FIRE"  position and resume firing, putting the safety back on "SAFE"  when you cease firing, even for a moment.

### EXTRACT AND EJECT A CHAMBERED CARTRIDGE

When the rifle is fired, the same gas pressure that drives the bullet forward bleeds through the gas port into the gas block, gas tube and into the gas key to push the bolt carrier to the rear. This action causes extraction and ejection of the fired cartridge case. If a cartridge fails to fire or if the shooter wishes to eject the chambered cartridge manually, follow the procedure described in "UNLOAD". When the charging handle is operated, there can be a failure to extract the cartridge from the chamber, or a failure to eject the cartridge clear of the rifle. These failures usually are the result of the charging handle not being pulled rearward vigorously. From the foregoing, the user must:

1. Always visually check the chamber after opening the action to eject a chambered cartridge. If the charging handle is not vigorously retracted, the extracted cartridge can be "ejected" into the magazine area.
2. Thoroughly clean the chamber and the extractor as often as necessary. If an empty magazine is in the rifle when the charging handle is being retracted to extract a cartridge, the cartridge may drop on top of the magazine or remain held to the bolt face by the extractor. Then, when the bolt carrier goes forward, the cartridge will be chambered again!

REMEMBER -- always remove the magazine before clearing the chamber, and visually check to ensure that no cartridges remain in the firearm.

## REMOVE A BORE OBSTRUCTION



Firearms which are chambered for small caliber high-velocity cartridges are particularly susceptible to damage from firing when the bore is obstructed. Excess oil, grease, or water may form an obstruction which could cause damage and injury. If you suspect that your rifle may have excess oil, grease, or other contaminants in the barrel. Or, if it may have been exposed to humid conditions, which could cause condensation, or to rain or snow, which might have entered the bore, open the bolt carrier and clean out the barrel. Inspect the bore visually to be sure that it is perfectly clear.

A firearm user should recognize that a lodged bullet is a fairly common form of bore obstruction. Therefore, the following information on how a bullet may become lodged in the bore, and how it should be removed, deserves most careful reading and understanding!

1. When firing, a bullet may become lodged in the bore if the cartridge contains no powder, insufficient powder, or the powder fails to ignite and only the primer charge ignites, producing insufficient force to propel the bullet out of the bore.
2. A bullet may also become lodged in the bore when extracting a cartridge from the chamber (unloading). If the bullet is not crimped tightly enough in the cartridge case, the bullet may stick in the bore, with only the case being extracted.

**Experience indicates that the two conditions described above occur most frequently with reloaded ammunition.**



When either of the above described (1 or 2) situations occur, proceed as follows *with the firearm pointing in a safe direction*:

- a. If the firearm is cocked, move the safety to the “SAFE”  position.
- b. Remove the magazine from the firearm.
- c. Retract the charging handle and lock it in the open position. Retracting the charging handle should remove the cartridge case. Be certain the safety is in the “SAFE”  position.
- d. Check the chamber to be certain there is no cartridge case in it – if there is, extract it before proceeding with steps (e) and (f).
- e. After making sure the chamber is clear and the magazine is removed, close the bolt, disengage the take down pin, remove the bolt and carrier and inspect the bore visually and with a rod as necessary.
- f. If the bore is obstructed, insert a proper size cleaning rod (without a tip or brush) into the bore from the muzzle and dislodge and remove the bullet. If the bullet does not readily dislodge, it may be necessary to lightly tap the handle end of the cleaning rod. If such efforts fail to dislodge the bullet, take the firearm to a gunsmith.
- g. Inspect the bore to be certain it is free of unburned powder particles or any other debris. At the same time clean the magazine, the magazine well, and other areas of the mechanism of unburned powder grains.

DO NOT ATTEMPT TO REMOVE A LODGED BULLET USING A BLANK CARTRIDGE OR A CARTRIDGE FROM WHICH THE BULLET HAS BEEN REMOVED, OR BY ANY MEANS OTHER THAN THE USE OF THE PROPER SIZE CLEANING ROD AND REASONABLE FORCE APPLIED TO THE ROD. BE CERTAIN ALL LOOSE POWDER HAS BEEN REMOVED FROM THE BORE AND ACTION BEFORE INTRODUCING THE ROD INTO THE BORE. NEVER TRY TO SHOOT OUT A BORE OBSTRUCTION!

### CLEAR A MALFUNCTION

If you experience a malfunction, study the situation to determine the nature of the malfunction and how best to clear it. Any auto-loading firearm may occasionally malfunction. If it does:

1. Be certain the muzzle is pointed in a safe direction and the safety is in the "SAFE"  mode.
2. When attempting to free a jammed cartridge, do not use any type of tool that is likely to act as a "firing pin" and discharge the cartridge should the tool impact on the primer. Never use a cartridge as a "tool."
3. After clearing a jam, inspect the firearm mechanism to determine if dirt or debris might be the cause of the problem. Excess lubricant or grease can cause cartridges to feed sluggishly. An accumulation of grease, dirt or powder grains in the magazine can contribute to cartridge feeding problems.
4. After clearing a jam, inspect all cartridges that have been removed from the firearm. Safely dispose of any cartridges which are dented or nicked or have bullets that are loose or improperly positioned in the cartridge case.
5. If it appears that the gun and magazine are not at fault and that the jam was caused by the type of cartridge being used, then try another type or brand of cartridge.
6. If the above procedures do not result in a smooth and reliable feeding firearm, do not use the firearm until it feeds cartridges smoothly and reliably. The firearm should be returned directly to POF-USA for repair. Contact [TECHNICAL@POF-USA.COM](mailto:TECHNICAL@POF-USA.COM) for packing and shipping information.
7. If a cartridge or shell is caught between the bolt carrier and receiver, put the safety on "SAFE" , retract the bolt carrier using the charging handle, and lock it in the open position using the bolt catch. Remove the magazine; then remove the jammed case.
8. If a fired cartridge case is in the chamber, use a cleaning rod to knock it out.
9. If an unfired cartridge is stuck in the chamber, keep the muzzle pointed in a safe direction with the safety in the "SAFE"  position. Close the bolt, disengage the take down pin, remove the bolt and carrier, and remove the unfired cartridge from the chamber end rather than trying to dislodge it with a cleaning rod inserted from the muzzle. Use a piece of 3/16" brass rod which has one end shaped like a screwdriver tip. Insert the tip in the extractor groove of the cartridge, use the face of the ejection port as a fulcrum and carefully pry out the cartridge. Be careful not to strike the primer area of the live cartridge! Vigorously brush-clean the chamber with solvent after clearing any jam involving the chamber.



**Information to Note:** *Form the habit of examining fired cartridge cases from time to time. If fired cases have bulged heads or show splits on any part of the case, stop using that ammunition. If the problem persists with different types of ammunition, contact TECHNICAL@POF-USA.COM.*

### MINIMIZE MALFUNCTIONS

Auto-loading firearms of all makes and types occasionally malfunction when a cartridge fails to feed from the magazine to the chamber, or when a cartridge (or fired case) fails to properly extract and eject. To minimize the possibility of such occurrences the gun user should:

1. Use ammunition of the correct caliber and type which is loaded to industry specifications. Avoid reloads, remanufactured cartridges, and cartridges that are dirty, corroded, or deformed.
2. Clean and lubricate the gun in accordance with the instructions in this manual and the instructional videos on the POF-USA website.
3. If the mechanism shows signs of not functioning correctly, or if a part is damaged or broken, do not use the firearm. Have it inspected and repaired.
4. Use only high-quality magazines and carefully load the magazine. Do not exceed the stated magazine capacity.
5. Do not “ride” the charging handle when chambering a cartridge from the magazine. The bolt carrier should be permitted to snap forward under the full force of the buffer spring. If a cartridge does not fully chamber, use the forward assist no more than twice to force the bolt carrier closed. If the cartridge is still not chambered completely, the round should be cleared as a jam.
6. To minimize the probability of an unfired cartridge being jammed should it “fall back” onto the magazine, remove the magazine *before* retracting the carrier. When extracting an unfired cartridge, tip the right side of the rifle towards the ground so that gravity will assist the cartridge to fall clear of the ejection port. Always retract the charging handle briskly when extracting a live cartridge. Take care to see that a cartridge is not forcibly ejected against a surface where the primer might be set off.

### DISASSEMBLY

1. With the rifle pointing in a safe direction, safety in the “SAFE”  position, remove the magazine by pushing the magazine catch button inward to release the magazine, while drawing magazine down.
2. Pull the charging handle all the way to the rear and push and hold the bottom tab of the bolt catch and release the charging handle. Make sure safety is in the “SAFE”  position.

**Information to Note:** *Hammer must be cocked to place the selector in the "SAFE" position. Again, be sure chamber is empty!* 



3. Remove the gas regulator by fully depressing the side button and twisting the regulator clockwise until the top notch (marked with an "N" for normal mode) loosens at 90 degrees. Then lift the regulator out of the gas block.



**Information to Note:**

*If disassembling the gas system after heavy shooting or after a long period of inattention, carbon deposits may make it difficult to rotate the gas plug (regulator). If this is the case, press the release button and insert the rim of a cartridge into the slot in the front of the plug and turn it clockwise to remove.*



4. Now dump the piston and operation rod out the front of the gas block and set aside. If the piston or rod do not fall out freely due to carbon buildup after sever use or inattention, operate the charging handle with one hand while the other hand is over the gas block to catch the piston as it pops out. This will assist in removing the piston and operation rod.

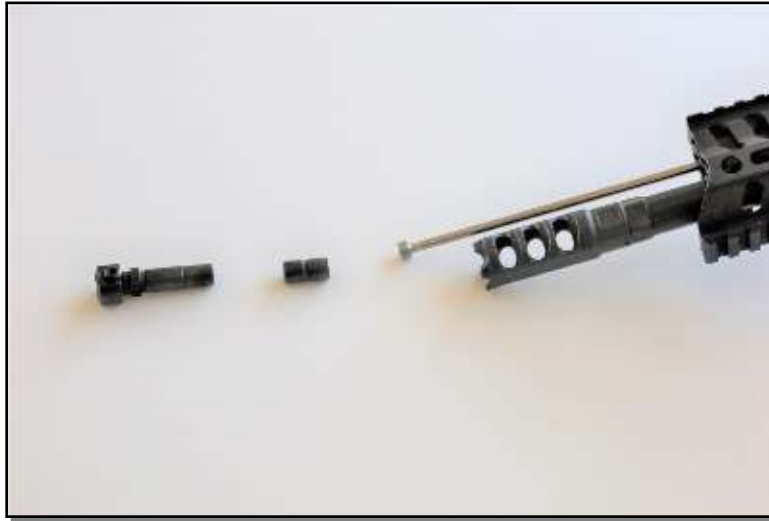

**Information to Note**

*Check Op-Rod by rolling on flat surface.*

**Gas Plug Orientation**

5 Position

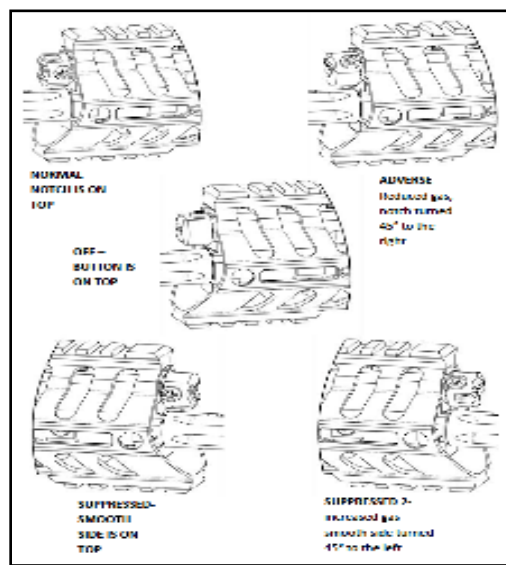



5. With the Bolt Carrier Group (BCG) forward into battery press the rear take down pin located on the left side of the lower receiver to the right. From the right side of the rifle, pull the pin outward until the detent stops any additional travel.



6. Tilt the upper receiver forward on the front pivot pin, remove the bolt carrier (BCG) and charging handle from the upper receiver.



7. If desired, remove the upper receiver from the lower receiver by pushing the pivot pin on the left side of the lower receiver to the right. Reach to the right-hand side of the lower receiver and pull the pivot pin to the right until the detent stops any additional travel.



8. Lift the upper receiver off of the lower receiver.



## BOLT CARRIER GROUP

After removing the Bolt Carrier Group (BCG) and the charging handle from the upper receiver, you can set the upper receiver aside.



Remove the BCG.



Remove the charging handle.

### Disassembly of the bolt carrier group (BCG):

Retrieve the bolt carrier group (BCG).

1. Remove the firing pin retaining pin by pulling it through the left side of the carrier.
2. Remove the firing pin out the back of the bolt and bolt carrier.
3. The roller cam pin can now be removed from the bolt carrier group.



- The bolt can now be slide out the front of the bolt carrier.



- The BCG is now disassembled down to a user level and is ready to clean.

**Information to Note:** *When cleaning the BCG be sure to clean the ejector, extractor, bolt face, and the locking lugs.*

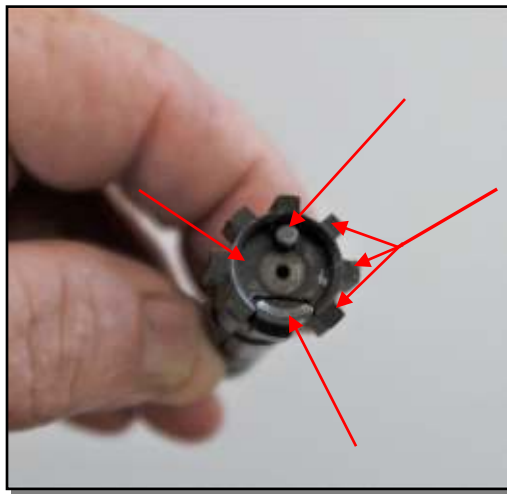

**The entire firearm is now ready for cleaning or maintenance**



## REASSEMBLY

Again, Be Sure the Firearm and Magazines are Completely Unloaded!

1. **Assemble BCG.** Start by reassembling the BCG in reverse order of the disassembly procedure on page 25.
2. **Reassemble the charging handle and bolt carrier into the upper receiver:**
  - a. Turn the upper receiver upside down so that the top of the rifle is pointing toward the ground.
  - b. Install the charging handle with the pickup lug pointing up.
  - c. Put the charging handle into the upper, line up the locator tabs with the corresponding cut in the upper and drop the charging handle into the charging hand slot.
  - d. Turn the bolt carrier upside down and, **making sure the bolt is fully forward**, place the key of the bolt carrier in channel of the charging handle, then push both the bolt carrier and the charging handle forward until the charging handle latch engages the upper receiver.

*Care should be taken not to turn the upper receiver so that the bolt carrier can slide out the back of the upper receiver while the charging handle is unlocked. The bolt carrier will not fall out of the upper receiver if the charging handle is locked on the upper receiver.*



**3. Assemble the upper receiver to the lower receiver:**

- a. Make sure the hammer is cocked, place the selector on “SAFE” , and make sure both the take down pin and pivot pin are pushed completely to the right side of the lower receiver.
- b. Make sure the bolt carrier is all the way forward in the upper receiver.
- c. Put the upper receiver onto the lower receiver and slide the upper receiver all the way rearward against the threaded section for the butt stock.
- d. Push the pivot pin into the receiver until the detent locks in the hole in the pivot pin. Push the take down pin into the receiver until the detent locks in the hole in the take down pin.



**CARE AND CLEANING**

After each shooting session, at regular intervals, or whenever your firearm has been exposed to sand, dust, extreme humidity, condensation, immersion in water, or other adverse conditions; disassemble, clean, and lubricate it using the techniques shown in the video that can be viewed either on YouTube or by going to the link on POF-USA’s website:

<http://pof-usa.com/support/> or <http://pof-usa.com/category/videos/cleaning/>

Basic Procedures are:

1. Disassemble the firearm as described on pages 20-25.
2. Clean the barrel bore with a bore brush, patches, and solvent using a cleaning rod.
3. Remove powder residue from all components and wipe with a clean cloth.
4. Only use a light application of oil on the riding surfaces of the bolt carrier group. Excessive oil will attract dust and dirt and may congeal in cold weather possibly interfering with the safe operation and reliable function of the firearm.

## WARRANTY POLICIES

All POF-USA (POF) products are manufactured in the USA using the finest quality materials and have a limited lifetime warranty. All POF firearms are warranted to be free from defective materials and workmanship. POF will repair or replace only those parts as determined to be defective by the factory. This warranty is limited and does not extend to careless handling, abuse and misuse, unauthorized adjustments or modifications, use of improper ammunition, excessive or unreasonable use, rust or corrosion or barrel obstruction.

Altering or modifying parts is dangerous and will void the warranty. Your POF-USA firearm was manufactured to perform properly with the original parts as designed. It is your responsibility to make sure any parts you install are made for this firearm, installed correctly, and that neither the originals nor the replacement parts are altered or changed. Your POF-USA firearm is a complex precision tool with many parts that must operate correctly with other parts in order to maintain proper and safe operation. Putting your firearm together improperly or with incorrect or modified parts can result in a damaged firearm, serious personal injury, or death to you and/or others through malfunction. Always have a qualified armorer or gunsmith work on your POF-USA firearm systems or other firearms.

Shipping to and from our facilities, government fees, damages caused by failure to perform normal maintenance, sales outside the United States, damages due to high velocity, high pressure, reloaded, remanufactured, or other non-standard ammunition, consequential or incidental damages and /or expenses, any unauthorized repair, modification, misuse, abuse, or alteration of the product is not covered by this warranty.

It is the responsibility of the owner to assure the weapon is properly maintained.

In order to help us assist you better, please register your firearm through our Warranty Registration online form below. This warranty is transferable from the original purchaser to a subsequent buyer. Warranty is established by registering online at [Warranty Registration - POF-USA \(pof-usa.com\)](http://www.pof-usa.com/Warranty-Registration).

For further technical assistance or to obtain warranty information on your POF-USA firearm, email technical support at [technical@pof-usa.com](mailto:technical@pof-usa.com).

## Maintenance and Wear Parts

POF has been manufacturing firearms and firearm components since 2002. Through extensive testing and use we have learned that almost any machine including all firearms will have certain parts that could occasionally require maintenance, adjustments or replacement. “Wearable” or “Consumable” parts are those parts that by their very nature, through use (functioning) will not maintain absolute factory specifications forever and will need to be monitored periodically for functionality and safety. Some of these parts may have a finite life cycle which could be affected by use, abuse, or maintenance.



To address these parts on our products, it is recommended that a POF firearm be disassembled and inspected by a certified POF armorer at least annually. Many of the problems that The Factory has encountered with customers returned firearms involve these “Wearable” or “Consumable” parts and or improper maintenance or cleaning.

### **“Wearable” or “Consumable” Parts**

*Below is a sample list of some wearable or consumable parts:*

#### **Springs**

Springs are very important to the safe and reliable operation of any firearm. They tend to be one of the most overlooked parts when performing maintenance. When they become worn through use or age they tend to anneal or take a set (become weak). This can change or adversely affect the operation or reliability of the firearm. In addition, any spring can be damaged, weakened, worn, or broken based on the use or abuse of the firearm and therefore should be inspected regularly and replaced as needed.

#### **Extractors**

Extractors are a high use component that must function correctly every time the firearm feeds or extracts a cartridge from the chamber to complete the cycles of operation. Because of this they are considered a “Wearable” part and should be inspected regularly and replaced as needed.

#### **Ejectors**

Ejectors are also a high use component that must function correctly every time the firearm ejects a cartridge from the chamber. Because of this they are considered a “Wearable” part and should be inspected regularly and replaced as needed.

#### **Firing Pins**

The Firing Pin contacts the cartridge primer anytime a round is loaded and anytime the rifle is fired. This can cause impact stress to the face of the firing pin and therefore it should be inspected regularly and replaced as needed.

#### **Cam Pins**

A Cam Pins is a crucial component that operates every time the rifle is cycled and is the main component that locks and un-locks the action. This part is a high cycle component and therefore should be inspected regularly and replaced as needed.

*Although we recommend that “Wearable” or Consumable” parts be inspected regularly it does not mean that these parts need to be replaced every time they are inspected. POF products are manufactured to the highest standards and tend to outlast other products on the market. To ensure long life and reliability of our products we recommend these inspections to insure continued reliability and long life of your POF product.*



## ADDITIONAL TECHNICAL INFORMATION AND RECOMMENDATIONS

### 1. Magazines

POF-USA only recommends the use of magazines that have anti-tilt followers in any of our .308/7.62x51 or 6.5 Creedmoor caliber firearms. Currently the only magazines that have anti-tilt followers are:

- a. Magpul Gen 3 PMAGS
- b. Lancer L7AWM

Use of any other magazines in our .308/7.62x51 caliber firearms may cause feeding or cycling issues.



### 2. Grip Removal

- a. Remove grip screw using a 3/16" Allen wrench.
- b. Carefully begin removing the grip by pulling downward on it, making sure not to bend the safety detent spring located at the top right corner of the grip.

- c. Remove the safety detent spring from the grip, and then retrieve the safety detent from the right side of the receiver.

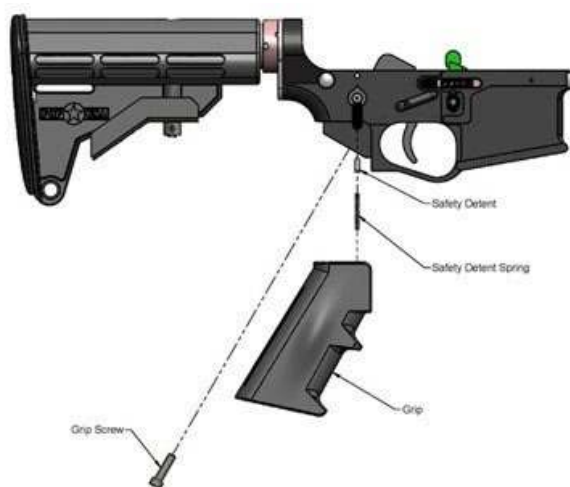

**ADDITIONAL TECHNICAL INFORMATION AND RECOMMENDATIONS CONTINUED**

**3. Ambidextrous Safety/Selector Switch Removal**

- a. With the hammer in the cocked position, remove the ambidextrous (right side) Safety/Selector screw using a 1/16" Allen or a T10 Torx wrench.
- b. Remove the right side Safety/Selector lever.
- c. Remove the triggers hammer retaining pin.
- d. Tilt the trigger to the rear to allow proper clearance for the body of the Safety/Selector to be removed out the left side of the receiver.
- e. Remove the Safety/Selector body out the left side of the receiver.
- f. To reinstall the Safety/Selector perform these steps in reverse.

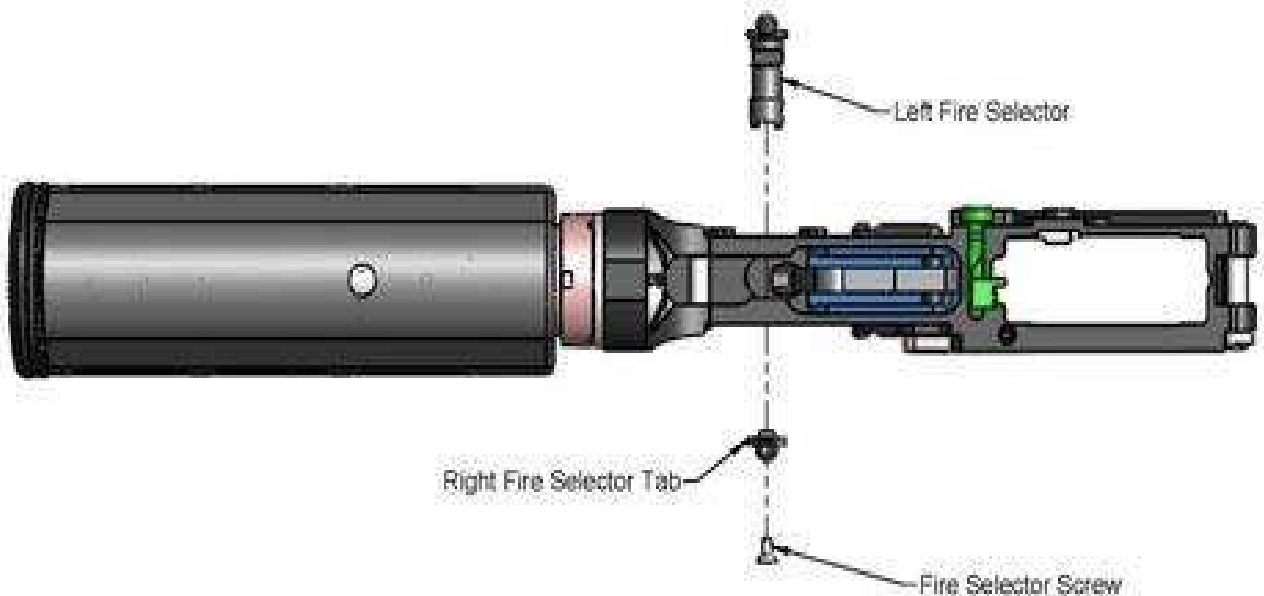



**ADDITIONAL TECHNICAL INFORMATION AND RECOMMENDATIONS CONTINUED**

**4. Revolution (CMR) Proprietary Buffer Tube, Buffer, and Spring**

- a. The bolt carrier on the Revolution (CMR) requires a longer travel stroke to allow clearance for the longer .308 and 6.5 cartridges and for clearance to eject the spent cases.
- b. Because of this, the Revolution (CMR) uses a proprietary (longer) buffer tube as well as a proprietary buffer spring. **Replacing the buffer tube or spring with an aftermarket product will result in the firearm being inoperable and/or damaged.**

**Note: STANDARD LENGTH AR15/M16 CARBINE BUFFER TUBES (RECEIVER EXTENSIONS), AND BUFFER/ACTION SPRINGS WILL NOT WORK IN THE REVOLUTION, REVOLUTION DI, OR ROGUE MODELS. DO NOT USE THEM, THEY WILL NOT WORK, AND YOU MAY DAMAGE YOUR FIREARM.**

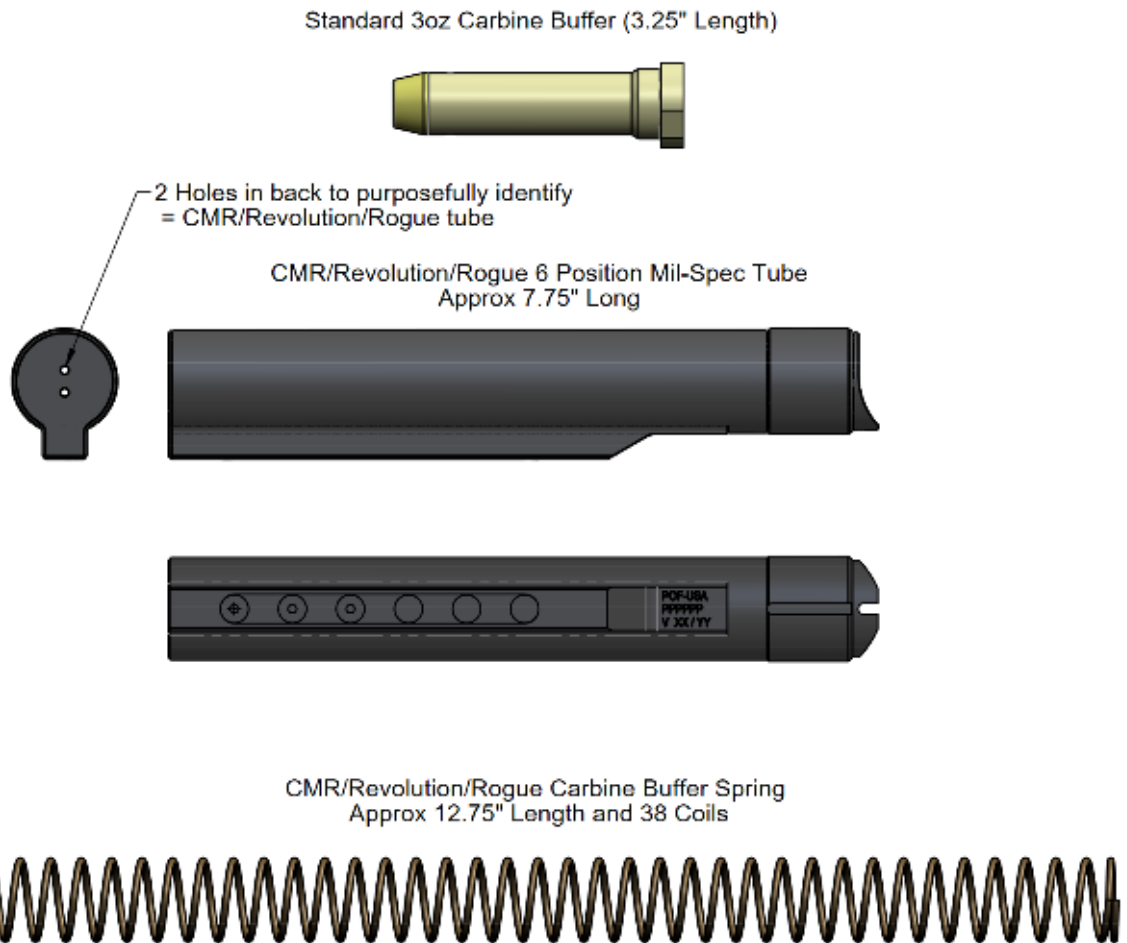

**ADDITIONAL TECHNICAL INFORMATION AND RECOMMENDATIONS CONTINUED**

**5. Transition from V1 to V2 bolt and firing pin for the Revolution (CMR)**

- a. The bolt on your Revolution (CMR) has been redesigned since it was originally introduced. Due to the nature of the redesign, the first version (V1) of the bolt and firing pin will not be compatible with the current version (V2).
- b. Download and review the file below for a visual comparison and explanation of and for the differences between V2 and V2 bolts and firing pins.

[Download Revolution \(CMR\) V1 vs V2 bolt and firing pin](#)

**6. Revolution (CMR) Charging handle Technical Bulletin**

- a. POF-USA and Mil-Spec AR-15/M-16 5.56/.223 charging handles are compatible with the Revolution (CMR) platform. Some other manufacturer's charging handles may not be compatible with the revolution platform due to their use of different internal geometry other than what is Mil-Spec.
- b. This difference could cause the carrier key to impact the channel of the charging handle resulting in damage to the charging handle and/or the firearm receiver in the area indicated in the link below.

[Download Revolution \(CMR\) charging handle comparison](#)

**7. Revolution (CMR) Extractor Spring Orientation Technical Bulletin**

- a. Orientation of the extractor spring is important to the functioning/cycling of this firearm.
- b. If you experience failures to feed or failures to extract and eject, especially after cleaning the bolt, you should check the orientation of the spring in the extractor.
- c. The extractor spring has a small end and a large end.
- d. If the small end has been inserted into the extractor pocket, it could work loose and either sit at an improper angle or completely come out of the pocket.
- e. This could result in a malfunction during extraction or feeding.

**Therefore, when re-inserting the spring on the Revolution (CMR) extractor, you should verify that the large coil end is placed into the extractor pocket.**



**ADDITIONAL TECHNICAL INFORMATION AND RECOMMENDATIONS CONTINUED**

**8. Trigger Removal and Installation**

- a. Please download the PDF below that explains how to properly remove and install your drop-in trigger.
- b. It is important that you install the selector **before installing the KNS pins**. You may break the tail of the trigger if you try to force the selector in after the KNS pins have been installed.

[Download Trigger Removal and Installation Instructions](#)

\*\*\*\*POF-USA DOES NOT RECOMMEND THE USE OF OUR DROP IN TRIGGERS IN ANY 9MM PCC CARBINES. \*\*\*\*

**9. Link to the POF-USA fastener reference guide.**

[Download POF-USA Fastener Guide.pdf](#)



Fastener Reference and Suggested Tools						
Location On Weapon	Fastener Description	Size	Quantity	Tool Size	Suggested Tool Description	Suggested Tool Description
Hand Guard, Wedge Block Screw (older)	Socket Set Screw, Cup Point	10-32 x 3/16	4	3/32	Allen Wrench, T-Handle	Allen Wrench, T-Handle
Rail Clamp Screws	Socket Head Cap Screw	10-32 x 3/8	2	5/32	Allen Wrench, T-Handle	Allen Wrench, T-Handle
Hand Guard, Back Bone Screw (older)	Socket Cap Screw, Flat	8-32 x 3/8	3	5/32	Allen Wrench, T-Handle	Allen Wrench, T-Handle
Hand Guard, Back Bone Screw	Socket Cap Screw, Flat	8-32 x 3/8	3	T20 TORX		TORX
Hand Guard, Rail Safe Screw, Bottom	Socket Set Screw, Cup Point	10-32 x 3/8	1	3/32	Allen Wrench, T-Handle	Allen Wrench, T-Handle
Hand Guard, Rail Safe Screw, Side MRP/P3D8	Socket Set Screw, Cup Point	1/8-28 x 3/8	2	1/8	Allen Wrench, T-Handle	Allen Wrench, T-Handle
Hand Guard, Rail Safe Screw, Side P Series	Socket Cap Screw, Low Head	10-32 x 1/4	2	3/32	Allen Wrench, T-Handle	Allen Wrench, T-Handle
Swivel Mount Screws (older)	Socket Cap Screw, Flat	10-32 x 3/8	2	1/8	Allen Wrench, T-Handle	Allen Wrench, T-Handle
Hand Guard Section Screws	Socket Cap Screw, Flat (5 slot)	10-32 x 3/8	2	T25 TORX		TORX
Hand Guard Section Screws	Socket Cap Screw, Flat (17 slot)	10-32 x 3/8	3	T25 TORX		TORX
Hand Guard Section Screws	Socket Cap Screw, Flat (8 slot)	10-32 x 3/8	2	T25 TORX		TORX
Sling Mount, Quick Release	Socket Cap Screw, Flat	10-32 x 3/8	2	T25 TORX		TORX
Carp Mount Screw, Long	Socket Cap Screw	1/4 - 28 x 1.5	1	3/16	Allen Wrench, T-Handle	Allen Wrench, T-Handle
Carp Mount Screw, Short	Socket Cap Screw	1/4 - 28 x 1	1	3/16	Allen Wrench, T-Handle	Allen Wrench, T-Handle
Ambi Selector Screw (older)	Flat Socket Cap Screw	4-40 x 1/4	1	1/16	Allen Wrench	Allen Wrench
Ambi Selector Screw	Flat Socket Cap Screw	4-40 x 1/4	1	T30 TORX		TORX
Trigger Anti Walk Kit Screws (older)	Socket Cap Screw, Button Head	6-40 x 15/64	2	5/64	Allen Wrench	Allen Wrench
Trigger Anti Walk Kit Screws	Socket Cap Screw, Button Head	6-40 x 15/64	2	T30 TORX		TORX
Ambi Bolt Release Screw						
Bolt Catch Screw						
Ambi- Mag Release Screw, Gen 4	POF-USA Proprietary Part		1	1/16	Allen Wrench	Allen Wrench
Nylon Tension Screws, Gen 4			1	1/16	Allen Wrench	Allen Wrench
Jam Nut for .308 WIN & 6.5 Creedmoor	Socket Set Screw, No Point	6-32 x .188	2	2	Allen Wrench	Allen Wrench
Muzzle Device for .308 WIN & 6.5 Creedmoor	5/8-24 Barrel Thread		1	20mm	Open End Box End Combo Wrench	Open End Box End Combo Wrench
Jam Nut for 5.56 NATO	5/8-24 Barrel Thread		1	3/4	Open End Box End Combo Wrench	Open End Box End Combo Wrench
Muzzle Device for 5.56 NATO	1/2-28 Barrel Thread		1	20mm	Open End Box End Combo Wrench	Open End Box End Combo Wrench
Jam Nut for 6.8 SPC, 7.62X39, & 300BLK	5/8-24 Barrel Thread		1	3/4	Open End Box End Combo Wrench	Open End Box End Combo Wrench
Muzzle Device for 6.8 SPC, 7.62X39, & 300BLK	5/8-24 Barrel Thread		1	20mm	Open End Box End Combo Wrench	Open End Box End Combo Wrench
Mil-Spec Castle Nut, Buffer Tube	Mil-Spec Standard Part		1	1	MAC535 - Magpul Armorer's Wrench	

.22 Fastener Reference and Suggested Tools						
Location On Weapon	Fastener Description	Size	Quantity	Tool Size	Suggested Tool Description	Suggested Tool Description
Barrel Mounting Screws	Socket Cap Screw, Flat	6-37X 3/8	4	T20 TORX		TORX
Mag Release Screw	Socket Set Screw, Cup Point	8-32X 1/8	1	5/64	Allen Wrench	Allen Wrench
EPD Adapter	1/2-28 Barrel Thread		1	5/8	Open End Box End Combo Wrench	Open End Box End Combo Wrench











**TRUE. AMERICAN. ORIGINAL.**

**Patriot Ordnance Factory**

Made in the U.S.A.

sales@pof-usa.com | POF-USA.com | 623-561-9572



 /POFUSA

 /POFUSA

 /PATRIOTORDNANCE

 /USER/POFUSA